

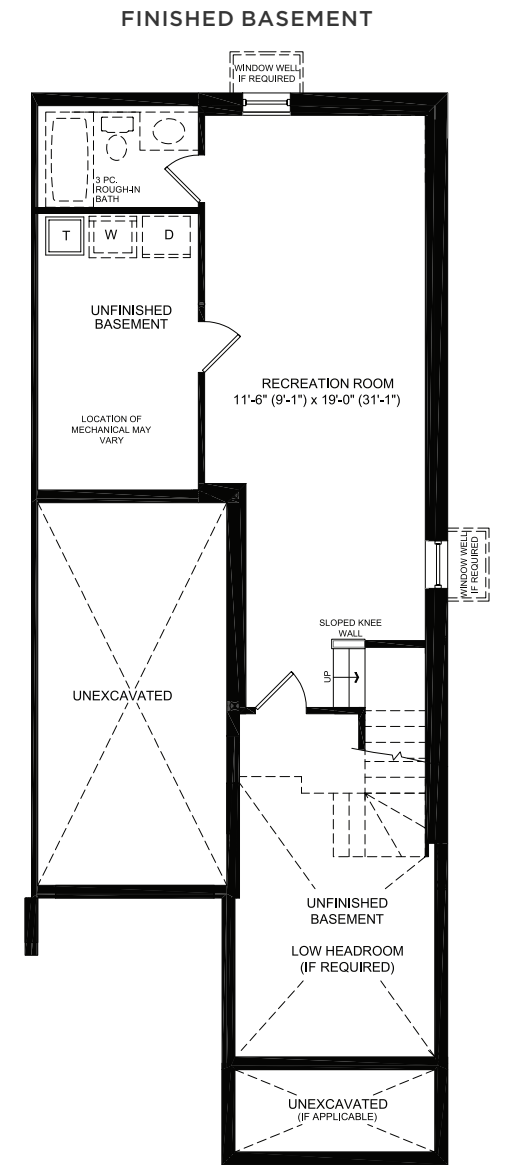

Floorplans

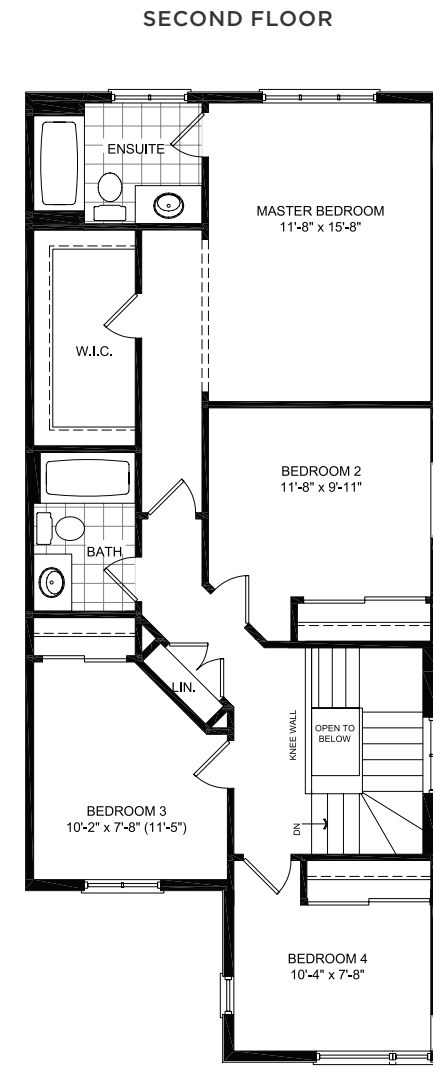
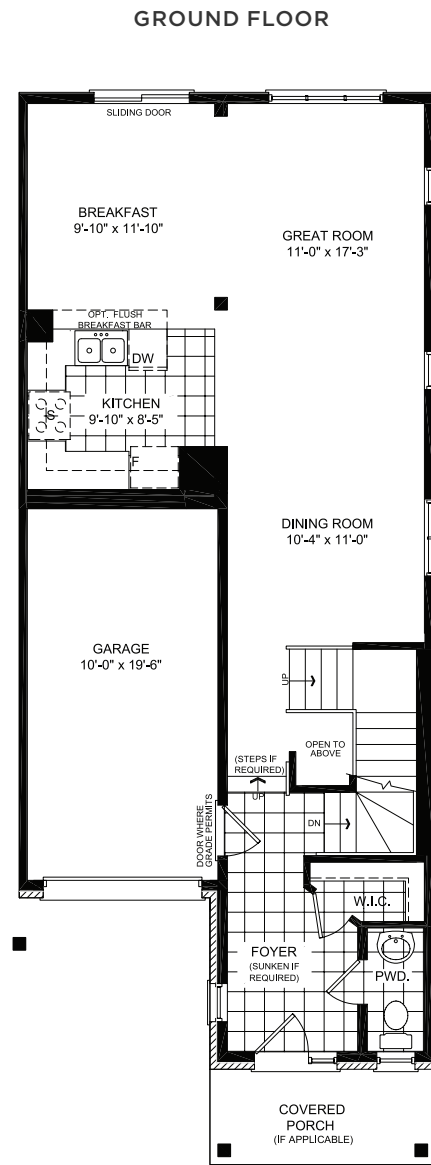

The Willow End

TOWNHOME COLLECTION
TOWNHOME (END UNIT) | 2,241 SQ. FT.

4 2.5 1

Designer Options

GOURMET KITCHEN

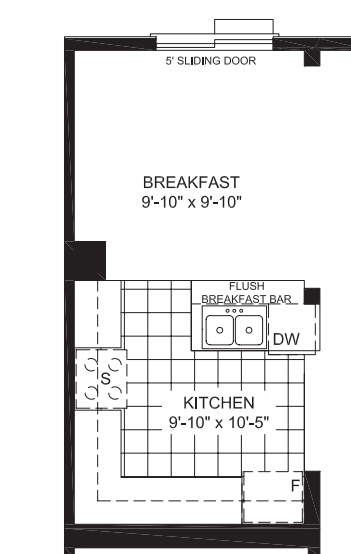

EXECUTIVE ENSUITE

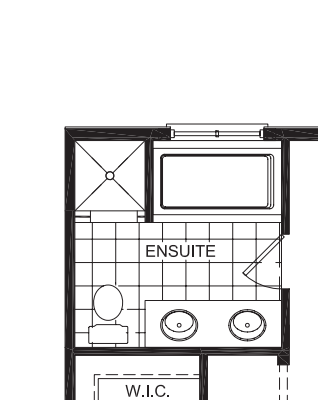

LOFT

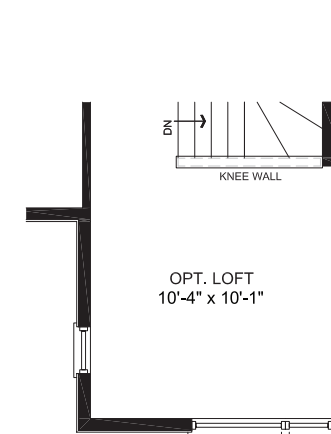

SECOND FLOOR LAUNDRY

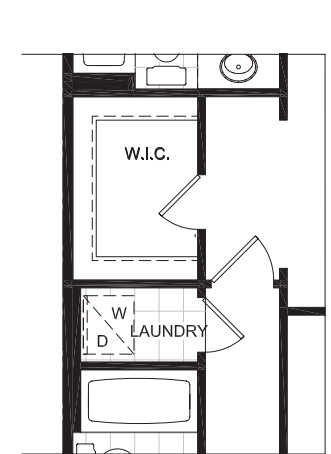

Despite the best efforts of Glenview Homes and its affiliates, officers, directors, employees or agents (collectively "we", "us" or "our" as circumstances warrant) to provide accurate information, including but not limited to prices and availability of homes or lots, it is regrettably not possible to ensure that all information contained in this display is correct. We do not warrant the accuracy and completeness of information, text, graphics or items contained in this display.

All dimensions provided are approximate and sizes and specifications are subject to change without notice. The floor plans and room dimensions shown apply to Elevation 'E' of this model type. Illustrations are artist's concepts only. Actual usable floor space varies from indicated floor areas. Square footages include finished space in the basement E.&O.E. THIS DISPLAY IS PROVIDED 'AS IS' WITHOUT WARRANTY OF ANY KIND, EITHER EXPRESSED OR IMPLIED, WARRANTIES OF MERCHANTABILITY, FITNESS FOR A PARTICULAR PURPOSE, OR NON-INFRINGEMENT. The information and specifications contained in this display are subject to change without notice and represent no commitment on our part in the future. All products and services are provided subject to applicable taxes and accompanying terms and conditions. DEC. 2022

